

Ventilation AAV (Air-Admittance Valve)

REDI



Ventilation System

Products for ventilation of the waste system:

- ARIO
- AAV (Air-Admittance Valve)
- Exhaling vent cowl
- Air-admittance valve for siphon bathroom/kitchen

Purposes:

- Eliminate bad smells and avoid syphons emptying
- Reduce discharge noise
- Improve drainage capacity (flow rate)
- Speed up discharge process

Norms:

- EN 12056 Air-admittance valve systems
- EN 12380 Air-admittance valves

Examples:

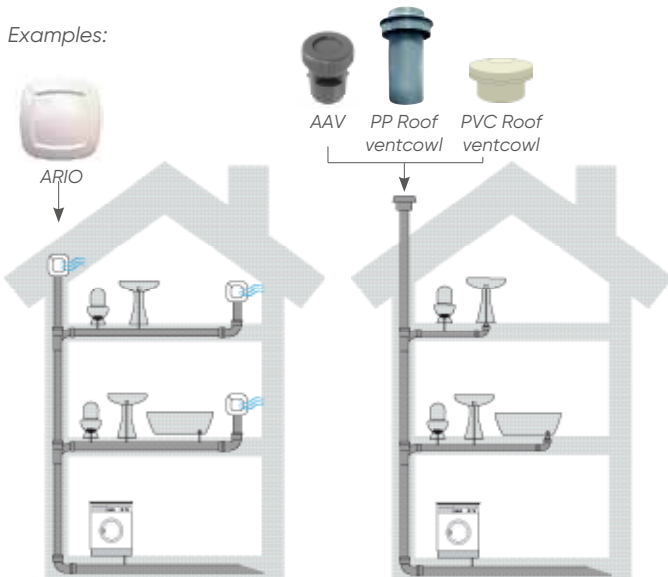

ARIO is particularly suitable for installation on concealed sanitation facilities, thanks to its design which makes it suitable to be applied in bathrooms, attics, stairwells.



The system designer has a broader flexibility of positioning and increase installation safety, thereby avoiding unexpected errors linked to pipe layout (leveling is required for other products).



Ario what it is and what it is used for

ARIO is an AAV, which has specific features and a revolutionary operating principle.

Thanks to a pre-loaded spring, which conveys the right pressure to the gasket seal, ARIO is able to operate regardless of its installation position. This feature makes it a unique product because it can be installed both inside and outside building.

Possible installation positions: top vertical / bottom vertical / horizontal/ diagonal.

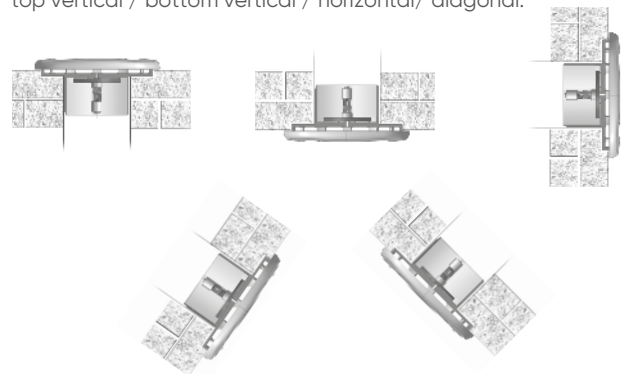

Operating position "CLOSED": it prevents bad smells emission.

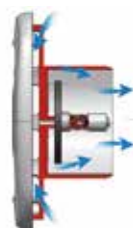

Operating position "OPEN": upon drainage, depressurization intakes air, which in turn opens the cover.

Sewage ventilation, why and how

In order to impede the expulsion of pungent odor gasses from the discharge system, the use of cut-off devices known as siphons (or traps) are integrated. The hydraulic seal generated prevents gas from escaping. There are many ways of designing a discharge system. In particular, the European standard EN 12056 describes the manner of sizing the discharge system and its relative ventilation. This standard has been implemented in Europe's main countries.

Conditions of pressurization and of depressurization come into being due to the water flow as the discharge system is operating. These pressure variations can cause problems to the traps: compression may result in trap "by-free" by the stagnant gasses, while depressurization may cause the siphon to empty (siphoning) with loss of the gas seal. Therefore, it is extremely important to compensate these effects by designing the drainage system for top efficiency, always taking ventilation into consideration. This allows drastic reduction of the pressure gradients that are generated as the system operates. System design must account both for both fluid and air flow, thus allowing these to circulate freely without acting on the siphon in undesired ways. Air intake into the discharge system can be performed by the implementation of specific devices known as ventilation chimney or ventilation valves. The use of ventilation valves allows air to enter, decreasing depressurization during discharge and that cause siphons to empty, while blocking pungent fumes from escaping.

Good design of a ventilation system allows:

- increase of discharge capacity
- reduction of noise generated during discharge
- thorough emptying of the system.

Siphoning

Siphoning is the first cause that involves emptying the traps within a building, from this point of view an effect of subordinate importance may be evaporation, that may lead to seal failure due to long periods of siphon inactivity.

The ventilation valve is a device designed to allow air intake when depressurization is generated within the system, thereby avoiding air intake by the siphons with consequential discharge.

The ARIO ventilation valve is designed to allow air intake that is suitable to the depressurization generated within the system due to the discharge flow, thus able to fully protect the siphons. As a result, this valve helps avoid the "siphoning" effect.

Without ventilation

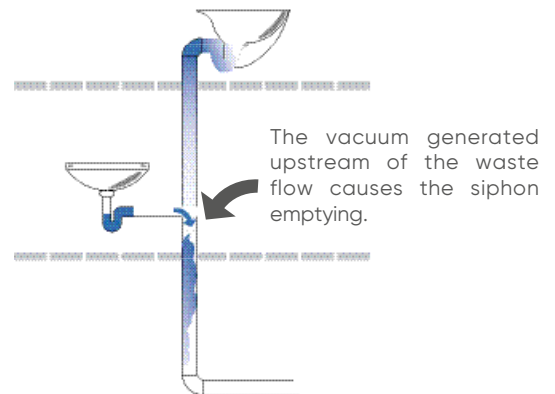

With ARIO

The air inlet compensates the vacuum generated in the waste system.

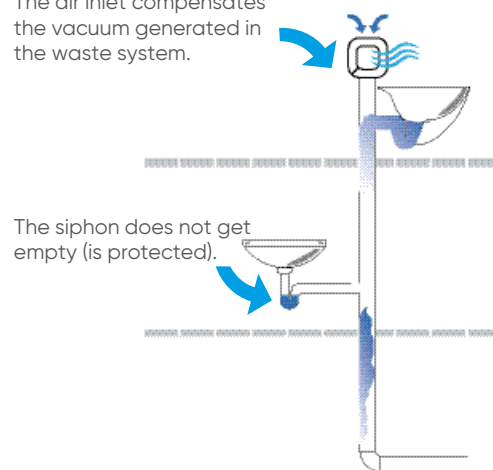

When installing a ventilation valve upstream of the horizontal section, the depressurization generated by discharge is compensated by air intake, thus protecting the sink siphon from the siphoning effect. Simultaneously, the valve remains closed to avoid release of foul odours after drainage. There are many applications for the device that must be considered during system design; however, the valve can be added to pre-existent systems. ARIO is designed to allow installation on both the secondary branches and on the main column.

Advantage of technology

One of the most important features is that ARIO, thanks to its seal tightness, allows inside installation. An example of application may be the case in which you want to avoid freeing the ventilation column through the roof outside the roof to benefit from technical and aesthetic advantages. This does not make it necessary to enter through building tops with the consequent risk of seepage. In addition, no more external chimneys are needed, which results in aesthetic advantage.

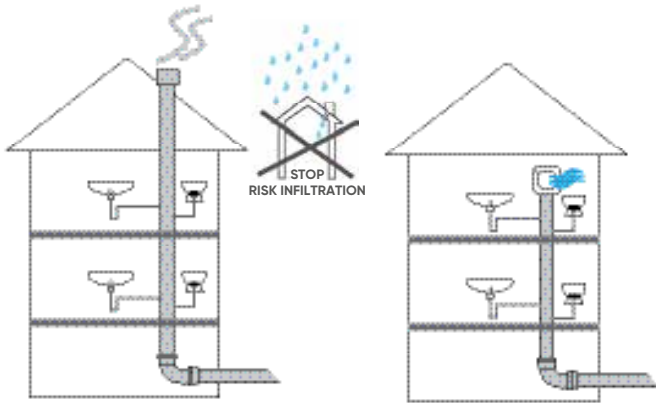

With ventilation chimney.

With ARIO ventilation valve.

Example of the advantages offered by this technology is the realization of ventilation for pre-existent systems. This can be achieved easily because using an ARIO valve means that no extension of the column, or of the branch at issue, is required. With the ARIO vent valve the installation can be performed inside the building in proximity of the manifold at issue. No floor free-through is necessary to reach the rooftop; and its design makes it perfect for bathroom installation.



Pre-existent system with no ventilation.

Ventilation is installed with ARIO.

This makes it possible to install the air inlet inside the building, i.e. in the stairwell of a condominium, given that there are no foul odours to expel outside. Installation is also possible in cases where we are in the proximity of an opening, such as a window, which requires compliance to air intake regulations. The following example shows valve installation near a window, on the side of the building, with no problems of fumes. ARIO can be installed onto the building side in clear view thanks to its flat design and insensitivity to installation position. The valve comes in an array of available colors and can be painted. Otherwise, the ventilation chimney would have to be installed on the roof.



Example of a discharge ventilation system with ARIO next to a window.

Compared Systems Solutions

Traditional way

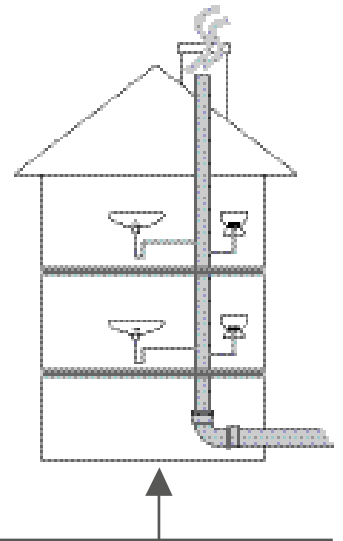

<i>Calculation example for the construction of a chimney to allow pipes to free through the rooftop.</i>	
Drill a smoke stack hole	€ 80,00
Water-proofing with 4 mm. Sheath	€ 24,00
Copper flashing to protect hole	€ 100,00
Protection chimney	€ 200,00
Total	€ 404,00
<small>The costs refer to realized installations - source data of 2011 Italy</small>	

Venting with ARIO

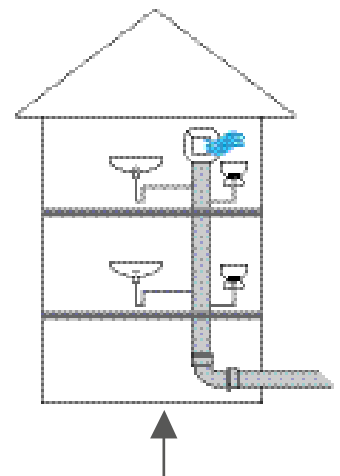

When a discharge system is designed using a vent valve such as ARIO, **no additional costs** are necessary. For example: a valve can be installed in the attic.

Aside from avoiding a series of installation-linked complications, water seepage from the roof is no longer a problem.

Technical Application

Below are represented a series of system layouts suitable to different system needs and typologies. The purpose is to outline several possible applications, not all those obtainable. Sizing must be executed in compliance with the reference regulations and local laws. An international standard accepted throughout Europe is EN 12056 that provides indications on discharge system sizing.

Diagram 1

Pressure regulation in the discharge column can be achieved by means of a venting channel; alternatively, a ventilation valve may be installed.

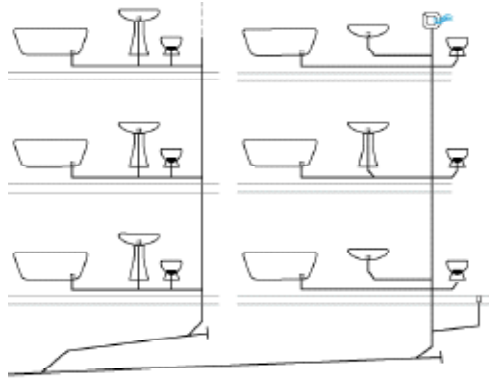

Diagram 2

Pressure control in the discharge branch can be achieved by means of a ventilation valve.

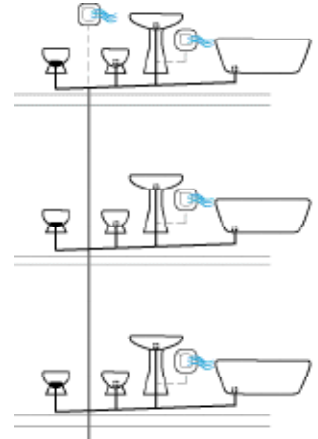

Diagram 3

Different ways of installing a ventilation systems. The use of a ventilation valve greatly simplifies the installation scheme, thus avoiding rooftop free-through while keeping the same efficiency.

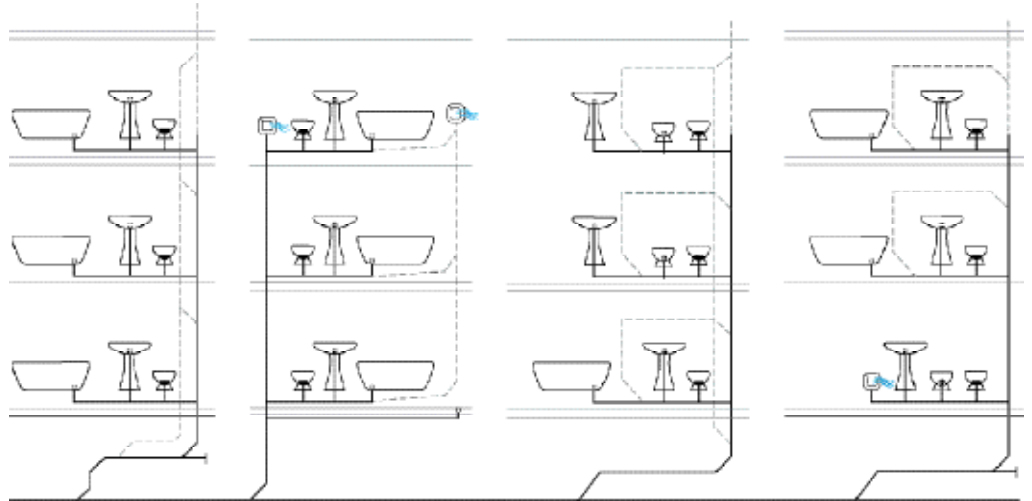
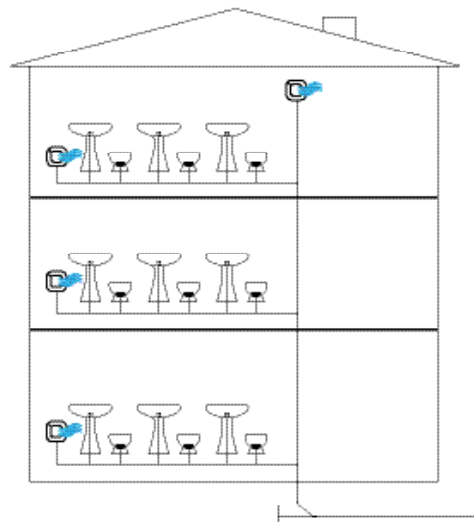

Diagram 4

ARIO vent can be considered as an effective solution for the ventilation of sequentially-installed systems (i.e. in tower buildings such as offices, schools, barracks) in a column of non-direct auxiliary ventilation. The system proves to be much simplified this way.



CE Marking

Ario 10

Air-admittance valves for drainage systems

EN 12380

Specifications:

- Name: **A II**
- Air flow capacity: **14 l/s**
- Air seal tested at: **10 KPa**
- Range of operating temperature: **from 0°C to 60°C**
- Subzero temperature performance: **NPD**

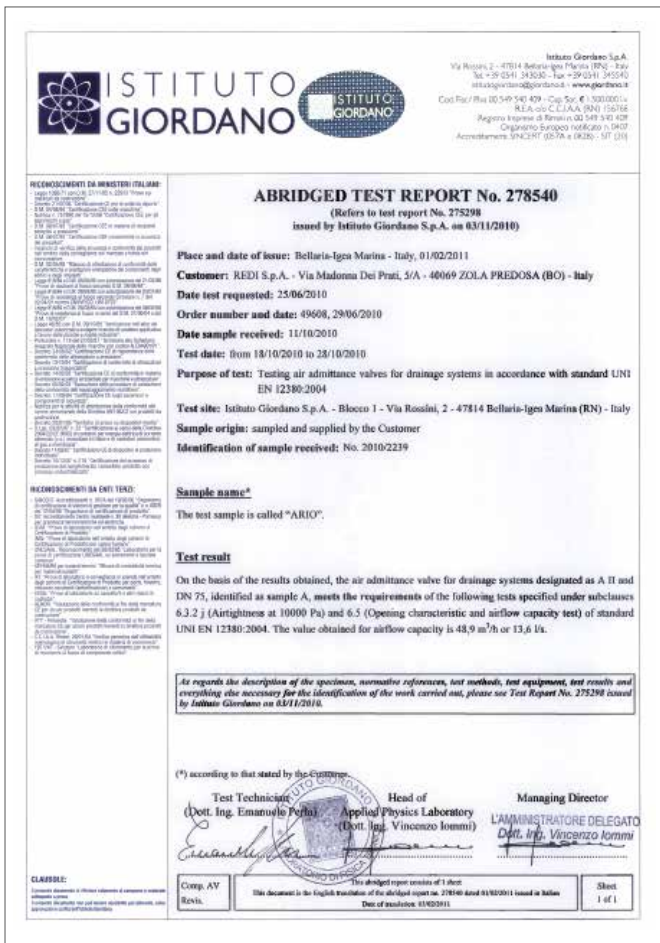

Certificate "ISTITUTO GIORDANO"

The certificates shown on this catalogue may be subject to revisions. Updated certificates for each product are available on website www.redi.it

Technical Specifications

The outside cover of ARIO can be removed when needed, to either allow verification of the proper operating conditions of the sealing disc, or look for any obstructions. This disc can be removed from its seat for further inspection.

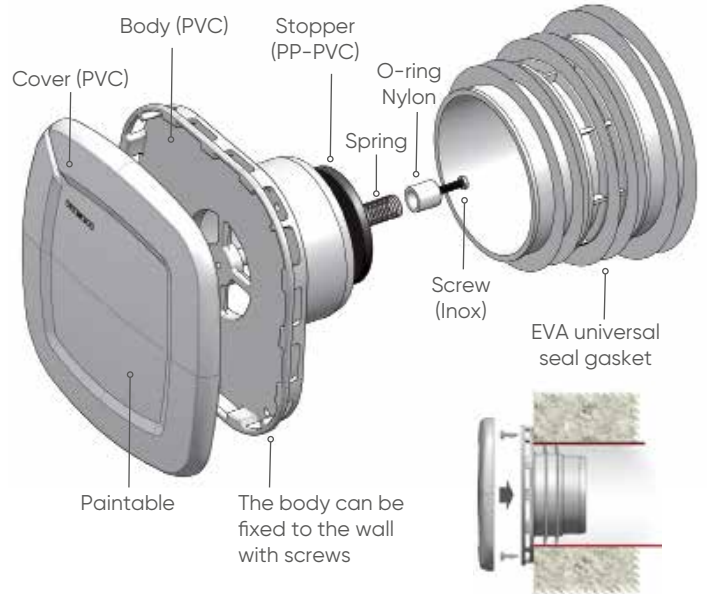

ARIO is designed to be installed through coupling. The valve can be directly inserted when dealing with Ø75 pipes (glue to a PVC) pipe. A special gasket is designed to allow fitting to a wide range of diameters – from Ø75 to Ø114.

The gasket is made of highly resistant EVA material and its shape makes it suitable to be trimmed to the desired diameter.

Assembling of the universal gasket (EVA)

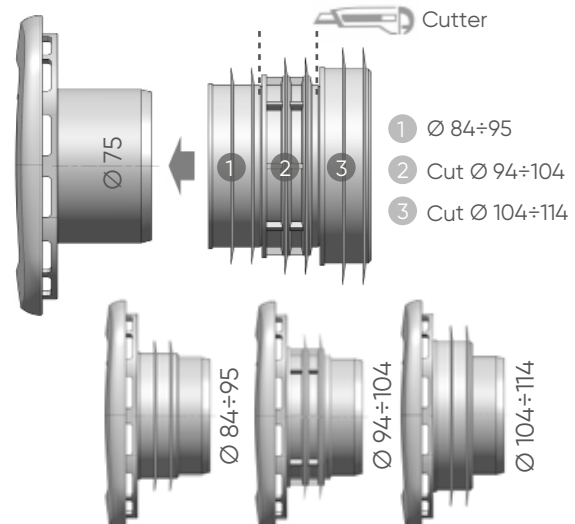





Ario

AAV - primary ventilation (universal, diameter range: Ø75 ÷ Ø114)

Soupape anti-vide (Ø75 ÷ Ø114)

Válvula de aireación (diámetro universal rango: Ø75 ÷ Ø114)

Dim. (mm)	Reference			Type	Note
146,6 x 146,6	169000W	1	306	White	universal gasket included
146,6 x 146,6	1690007	1	306	Dark brown	universal gasket included

Available in single package, also including universal gasket

Adaptor required: Ø84÷95; Ø94÷104; Ø104÷110

For the kitchen, Ø75 can be directly inserted.



Dark brown

Universal, diameter range:
Ø 75 ÷ Ø 114

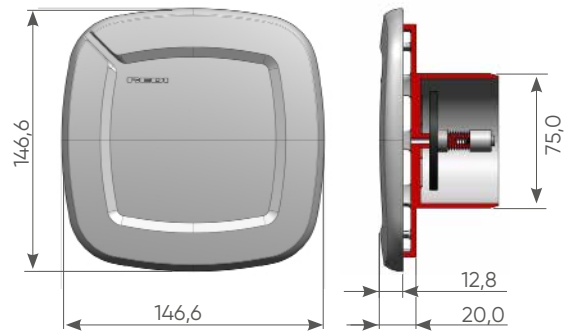

EN 12380 ¹⁰

- Description: **A II**
- Airflow rate: **14 l/s**
- Air tightness tested at: **10 KPa**
- Temperature range: **0°C at 60°C**
- Effectiveness at low temperature (below zero): **NPD**

Packaging: display box (9 piece-box)



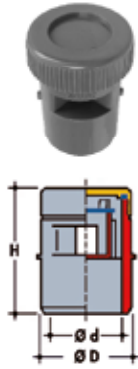

PVC Air-admittance valve (AAV)

Clapet à membrane en PVC - Aireador de membrana en PVC

DN M - F	H (mm)	Reference			Note
40 - 32	68	WAM430M	1	2.880	
63 - 50	84	WAM650M	1	240	
80 - 75	87	WAM870M	1	1.040	
110 - 100	132	WAM110M	1	480	

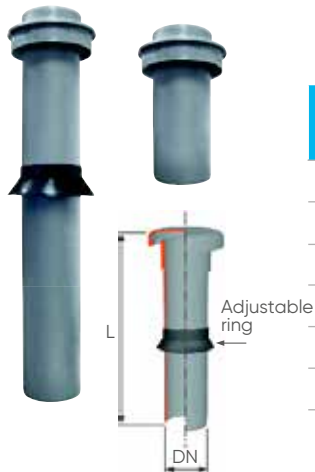

PP Ventpipe

Cheminée de ventilation de colonne en PP
Sombrete de ventilación PP

DN M - F	Reference			L (mm)	Note
50	Z7950PP	10	180	800	long version
75	Z7975PP	5	120	800	long version
110	Z7911PP	5	45	800	long version
50	Z8050PP	20	320	280	short version
110	Z8011PP	10	120	280	short version

PVC Roof ventcowl

Chapeau de ventilation en PVC - Sombrete de ventilación PVC

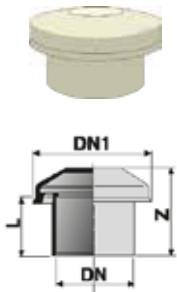

DN (mm)	DN1 (mm)	Reference						L1 (mm)	Z (mm)
		Ivory RAL 1013	Orange RAL 2003	Brown RAL 8017	Grey RAL 7035				
50	137	1690503	-	-	1690502	5	900	36	120
63	137	1690603	-	-	1690602	5	850	38	64
75	-	-	-	-	1690702	20	700	-	-
80	137	1690803	-	1690807	-	-	-	46	69
82	-	1698203	-	-	-	5	500	-	-
100	162	1691003	1691009	1691007	1691002	15	360	56	84
110	178	1691103	-	-	-	10	300	61	89
125	162	1691203	-	-	-	10	300	60	165